

Inclinometers

Sensor type	Axis	Range	Supply voltage	Output	Offset Temperature dependency	Sensitivity	Frequency response (-3dB)	Shipping Package sizes and orders codes	Dimension	Weight
SCA61T-FAHH1G	1 (X)	±30° (±0.5g)	5V	Analog & SPI	±0.86° (-40...+125°C) typ.: ±0.17° (-5...+70°C)	4V/g	8...28Hz	T&R 100 pcs: SCA61T-FAHH1G-1+S00621 T&R 600pcs: SCA61T-FAHH1G-6+S00622	10.48 x 11.31 x 5.08	0.74g
SCA61T-FA1H1G	1 (X)	±90° (±1g)	5V	Analog & SPI	±0.86° (-40...+125°C) typ.: ±0.17° (-5...+70°C)	2V/g	8...28Hz	T&R 100 pcs: SCA61T-FA1H1G-1+S00624 T&R 600pcs: SCA61T-FA1H1G-6+S00625		
SCA830-D07	1 (Y)	±90° (±1g)	3.3V	SPI	±1.7° (-40...+125°C) typ.: ±0.6° (-5...+70°C)	32,000 Count/g	6.25Hz (Typical)	T&R 100 pcs: SCA830-D07-1+S00105 T&R 1000pcs: SCA830-D07-10+S00108	8.6 x 7.6 x 3.3	0.31g
SCA100T-D01	2 (XY)	±30° (±0.5g)	5V	Analog & SPI	±0.86° (-40...+125°C) typ.: ±0.2° (-5...+70°C)	4V/g	8...28Hz	T&R 100 pcs: SCA100T-D01-1+S00551 T&R 600pcs: SCA100T-D01-6+S00552	15.58 x 11.31 x 5.08	1.01g
SCA100T-D02	2 (XY)	±90° (±1g)	5V	Analog & SPI	±0.86° (-40...+125°C) typ.: ±0.2° (-5...+70°C)	2V/g	8...28Hz	T&R 100 pcs: SCA100T-D02-1+S00554 T&R 600pcs: SCA100T-D02-6+S00553		
SCA103T-D04	1 (X)	±15° (±0.26g)	5V	Analog & SPI	±0.29° (-40...+125°C) typ.: ±0.08° (-5...+70°C)	16V/g	8...28Hz	T&R 100 pcs: SCA103T-D04-1+S00541 T&R 600pcs: SCA103T-D02-6+S00542	15.58 x 11.31 x 5.08	1.01g
SCA103T-D05	1 (X)	±30° (±0.5g)	5V	Analog & SPI	±0.29° (-40...+125°C) typ.: ±0.08° (-5...+70°C)	8V/g	8...28Hz	T&R 100 pcs: SCA103T-D05-1+S00544 T&R 600pcs: SCA103T-D05-6+S00543		



Inclinometer Modules

Sensor type	Axis	Range	Supply voltage	Output	Offset Temperature dependency	Sensitivity	Frequency response (-3dB)	Shipping Package sizes and orders codes	Dimension	Cable
SCA121T-D03	2 (XY)	±90° (±1g)	7...35V	Analog	±0.5° (0...+70°C) ±1° (-25...+85°C)	2V/g	8...28Hz	20 Pcs Tray: SCA121T-D03+S00521	41 x 42 x 14	30 cm (PUR black)
SCA121T-D05	2 (XY)	±90° (±1g)	5V	Analog	±0.5° (0...+70°C) ±1° (-25...+85°C)	2V/g	8...28Hz	10 Pcs Tray: SCA121T-D05+S00524	42 x 42 x 14	110 cm (PUR black)
SCA121T-D07	2 (XY)	±30° (±0.5g)	7...35V	Analog	±0.5° (0...+70°C) ±1° (-25...+85°C)	4V/g	8...28Hz	20 Pcs Tray: SCA121T-D07+S00525	43 x 42 x 14	30 cm (PUR black)
SCA121T-D09	2 (XY)	±90° (±1g)	5V	Analog	±0.5° (0...+70°C) ±1° (-25...+85°C)	2V/g	8...28Hz	10 Pcs Tray: SCA121T-D09+S00527	44 x 42 x 14	150 cm (high flexibility, PUR grey)
SCL1700-D01	2 (XY)	±10°	7...35V	Analog	±0.2° (0...+70°C) ±0.5° (-25...+85°C)	200mV/g	3Hz	45 Pcs Tray: SCL1700-D01+S00630	45 x 45 x 10	None



* Please note that specifications may change without prior notice.

Dimensions

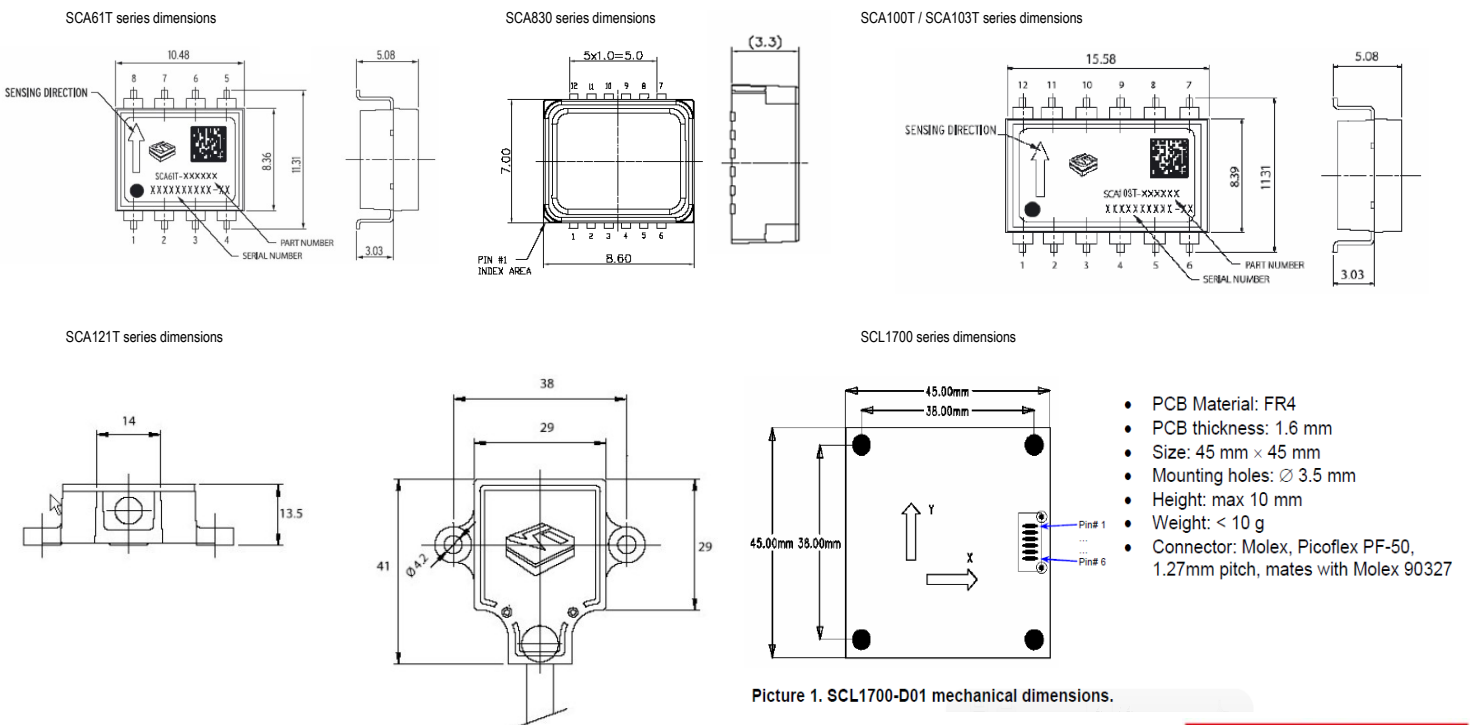

1, 2 and 3 axis Accelerometers

Sensor type	Axis	Range	Supply Voltage	Output	Offset Temperature dependency	Sensitivity	Frequency response (-3dB) typical	Shipping Package sizes and orders codes	Dimension	Weight
SCA610-E23H1A	1 (X)	±1.5g	5V	Analog	±125mg (-40...+125°C)	1.33V/g	50	T&R 100 pcs: SCA610-E23H1A-1+S00871 T&R 600pcs: SCA610-E23H1A-6+S00873	10.48x11.31x5.08	0.74g
SCA610-E28H1A	1 (X)	±1.7g	5V	Analog	±125mg (-40...+125°C)	1.2V/g	50	T&R 100 pcs: SCA610-E28H1A-1+S00885 T&R 600pcs: SCA610-E28H1A-6+S00887	10.48x11.31x5.08	
SCA620-EF8H1A	1 (Z)	±1.7g	5V	Analog	±125mg (-40...+125°C)	1.2V/g	50	T&R 100 pcs: SCA620-EF8H1A-1+S00990 T&R 600pcs: SCA620-EF8H1A-6+S01002	10.48x11.31x5.08	0.74g
SCA620-EF1V1B	1 (Z)	0...+2g	5V	Analog	±125mg (-40...+125°C)	2.0V/g	50	T&R 100 pcs: SCA620-EF1V1B-1+S00331 T&R 600pcs: SCA620-EF1V1B-6+S00332	10.48x11.31x5.08	
SCA630-EDCV1B	1 (Y)	-12...+13g	5V	Analog	±125mg (-40...+125°C)	0.15V/g	400Hz	T&R 100 pcs: SCA630-EDCV1B-1+S00348 T&R 600pcs: SCA630-EDCV1B-6+S00347	10.48x11.31x5.08	0.31g
SCA720-D01	1 (Z)	-1...+3g	5V	Analog	±125mg (-40...+125°C)	0.94V/g	115Hz	T&R 100 pcs: SCA720-D01-1+S01003 T&R 1000pcs: SCA720-D01-10+S00675	8.6x7.6x3.3	
SCA820-D04	1 (Z)	±2g	3.3V	PWM & SPI	±30mg (-40...+125°C)	900 Count/g	50	T&R 100 pcs: SCA820-D04-1+S00045 T&R 1000pcs: SCA820-D04-10+S00049	8.6x7.6x3.3	0.31g
SCA830-D06	1 (Y)	±2g	3.3V	PWM & SPI	±30mg (-40...+125°C)	900 Count/g	50	T&R 100 pcs: SCA830-D06-1+S00092 T&R 1000pcs: SCA830-D06-10+S00094	8.6x7.6x3.3	
SCA1000-D01	2 (XY)	±1.7g	5V	Analog & SPI	±100mg (-40...+125°C)	1.2V/g	50	T&R 100 pcs: SCA1000-D01-1+S00335 T&R 600pcs: SCA1000-D01-6+S00450	15.58x11.31x5.08	1.01g
SCA100T-D07	2 (XY)	±12g	5V	Analog & SPI	±300mg (-40...+125°C)	0.17V/g	400Hz	T&R 100 pcs: SCA100T-D07-1+S00560 T&R 600pcs: SCA100T-D07-6+S00581	15.58x11.31x5.08	
SCA1000-N1000070	2 (XY)	±4g	5V	Analog & SPI	±60mg (-40...+125°C)	0.55V/g	115Hz	T&R 100 pcs: SCA1000-N1000070-1+S00362 T&R 600pcs: SCA1000-N1000070-6+S00363	15.58x11.31x5.08	0.31g
SCA1020-D06	2 (YZ)	±1.7g	5V	Analog & SPI	±50mg (-40...+125°C)	1.2V/g	50	T&R 100 pcs: SCA1020-D06-1+S00405 T&R 600pcs: SCA1020-D06-6+S00406	15.58x11.31x5.08	
SCA2100-D02	2 (XY)	±2g	3.3V	SPI	±30mg (-40...+125°C)	900 Count/g	45Hz	T&R 100 pcs: SCA2100-D02-1+S00003 T&R 1000pcs: SCA2100-D02-10+S00004	8.6x7.6x3.3	0.31g
SCA2110-D04	2 (XZ)	±2g	3.3V	SPI	±30mg (-40...+125°C)	900 Count/g	45Hz	T&R 100 pcs: SCA2110-D04-1+S01004 T&R 1000pcs: SCA2110-D04-10+S01005	8.6x7.6x3.3	
SCA2120-D06	2 (YZ)	±2g	3.3V	SPI	±30mg (-40...+125°C)	900 Count/g	45Hz	T&R 100 pcs: SCA2120-D06-1+S00081 T&R 1000pcs: SCA2120-D06-10+S00085	8.6x7.6x3.3	0.31g
SCA3060-D01	3 (XYZ)	±2g	3.3V	SPI	±200mg (-40...+105°C)	1000 Count/g	9/35Hz	T&R 100 pcs: SCA3060-D01-1+S00587 T&R 1000pcs: SCA3060-D01-10+S00615	8.6x7.6x3.3	
SCA3100-D04	3 (XYZ)	±2g	3.3V	SPI	±70mg (-40...+125°C)	900 Count/g	45Hz	T&R 100 pcs: SCA3100-D04-1+S00162 T&R 1000pcs: SCA3100-D04-10+S00163	8.6x7.6x3.3	0.31g
SCA3100-D07	3 (XYZ)	±6g	3.3V	SPI	±100mg (-40...+125°C)	650 Count/g	45Hz	T&R 100 pcs: SCA3100-D07-1+S00167 T&R 1000pcs: SCA3100-D07-10+S00170	8.6x7.6x3.3	

Demo Kits

Sensor type	Axis	Range	Supply Voltage	Output	Picture
SCA8X0 D0X DEMO	1	±2g	No required (Through USB)	Raw data to PC through USB, Windows display SW	
SCA3100 D0X DEMO	3	±2g / 6g			

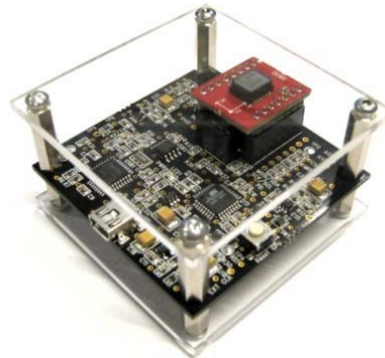

* Please note that specifications may change without prior notice.

SCA100T / SCA1000 series dimensions

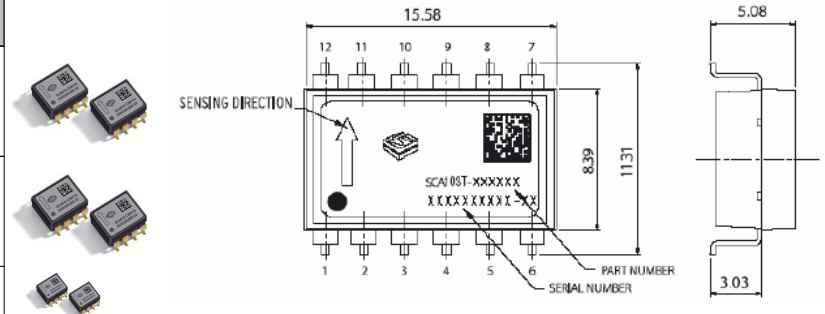

SCA800 / SCA3060 / SCA3100 series dimensions

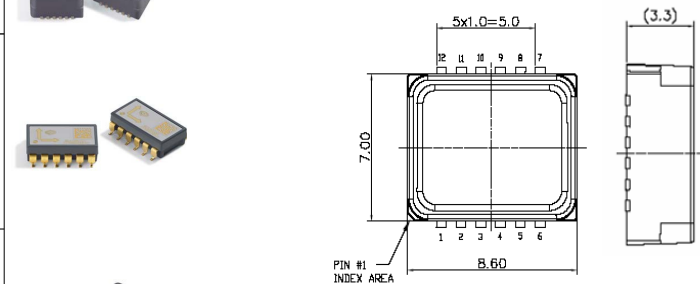

SCA610 / SCA620 series dimensions

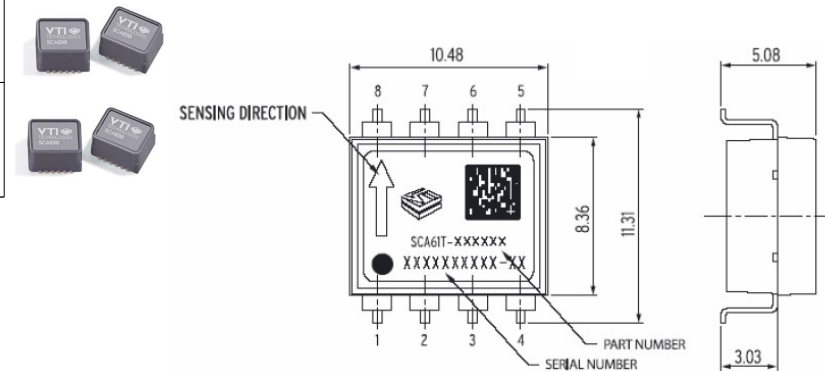

Gyro combo / gyro sensors



Sensor type	Axis	Range	Supply voltage	Output	Offset Error Over Temperature (-40...+125°C)	Sensitivity	Frequency response (-3dB)	Shipping Package sizes and orders codes	Dimension	Weight
SCR1100-D02	1 axis gyro (X)	100°/s	3.3 & 5.0V	SPI	±0.6°/s	50 Count°/s	50Hz (Typical)	T&R 50 pcs: SCR1100-D02-05+S00770 T&R 600pcs: SCR1100-D02-6+S00771	12.1 x 19.71 x 4.53mm	1.17g
SCR1100-D04	1 axis gyro (X)	300°/s	3.3 & 5.0V	SPI	±0.9°/s	18 Count°/s	50Hz (Typical)	T&R 50 pcs: SCR1100-D04-05+S00496 T&R 600pcs: SCR1100-D04-6+S00495		
SCC1300-D02	3axis Acc	±2g	3.3 & 5.0V	SPI	±18mg	1800 count/g	30...55Hz	T&R 50 pcs: SCC1300-D02-05+S00483 T&R 600pcs: SCC1300-D02-6+S00482	12.1 x 19.71 x 4.53mm	1.17g
	1 axis gyro (X)	100°/s			±0.6°/s	50 Count°/s	50Hz (Typical)			
SCC1300-D04	3axis Acc	±6g	3.3 & 5.0V	SPI	±40mg	650 count/g	30...55Hz	T&R 50 pcs: SCC1300-D04-05+S00485 T&R 600pcs: SCC1300-D04-6+S00814	12.1 x 19.71 x 4.53mm	1.17g
	1 axis gyro (X)	300°/s			±0.9°/s	18 Count°/s	50Hz (Typical)			

Demo Kits

Sensor type	Axis	Range	Supply voltage	Output	(WxLxH)
SCC1300-D04 DEMO	3axis Acc	±2g or ±6g	No required (Through USB)	Raw data to PC through USB, Windows display SW	62 x 62 x 39mm
	1 axis gyro (X)	100°/s or 300°/s			
SCx1300-D0x PWB	3axis Acc	±2g or ±6g	No required (Through USB)	Raw data to PC through USB, Windows display SW	43x28x15mm
	1 axis gyro (X)	100°/s or 300°/s			

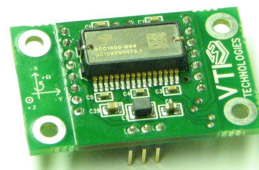

* Please note that specifications may change without prior notice.

SCC1300 series dimensions

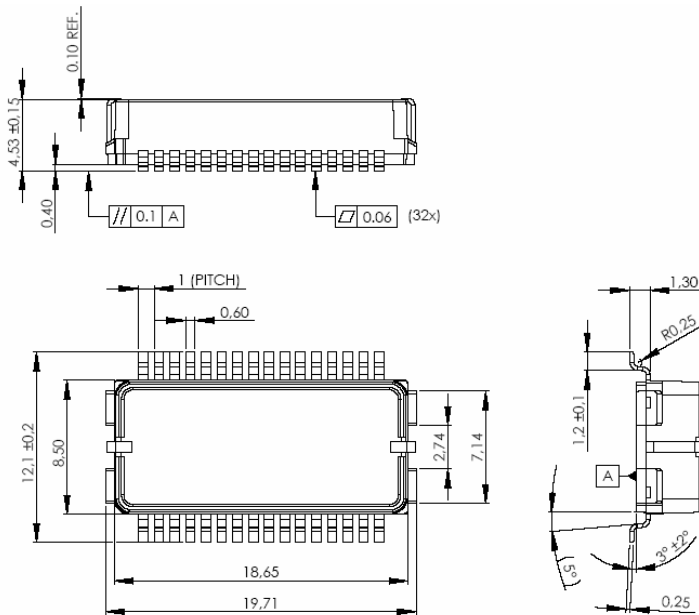

ГРУППА КОМПАНИЙ
АЛКОН
Санкт-Петербург,
ул. Геологическая, 79
тел. (812) 449-49-94
www.alkon.net

